



N-Channel 30-V (D-S) Fast Switching MOSFET

PRODUCT SUMMARY		
V_{DS} (V)	$r_{DS(on)}$ (Ω)	I_D (A)
30	0.013 @ $V_{GS} = 10$ V	13.3
	0.015 @ $V_{GS} = 4.5$ V	12.4
	0.022 @ $V_{GS} = 2.5$ V	10.2

FEATURES

- TrenchFET® Power MOSFET
- New Low Thermal Resistance PowerPAK™ Package with Low 1.07-mm Profile

APPLICATIONS

- Lilon Battery Protection

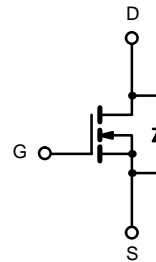
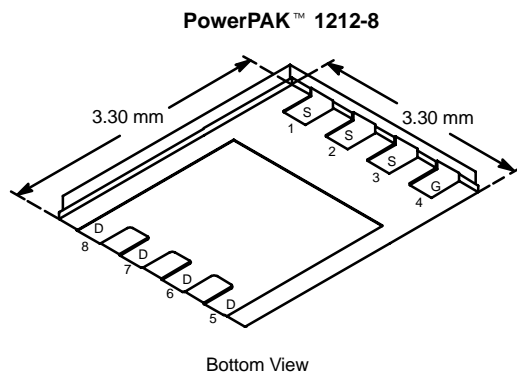

N-Channel MOSFET

ABSOLUTE MAXIMUM RATINGS ($T_A = 25^\circ\text{C}$ UNLESS OTHERWISE NOTED)					
Parameter		Symbol	10 secs	Steady State	Unit
Drain-Source Voltage		V_{DS}	30		V
Gate-Source Voltage		V_{GS}	± 12		
Continuous Drain Current ($T_J = 150^\circ\text{C}$) ^a	$T_A = 25^\circ\text{C}$	I_D	13.3	8.5	A
	$T_A = 70^\circ\text{C}$		10.6	6.8	
Pulsed Drain Current		I_{DM}	40		
Single Avalanche Current		I_{AS}	15		
Single Avalanche Energy (Duty Cycle 1%)		E_{AS}	11		mJ
			0.1 mH		
Continuous Source Current (Diode Conduction) ^a		I_S	3.2	1.3	A
Maximum Power Dissipation ^a	$T_A = 25^\circ\text{C}$	P_D	3.8	1.5	W
	$T_A = 70^\circ\text{C}$		2.0	0.8	
Operating Junction and Storage Temperature Range		T_J, T_{stg}	-55 to 150		$^\circ\text{C}$

THERMAL RESISTANCE RATINGS					
Parameter		Symbol	Typical	Maximum	Unit
Maximum Junction-to-Ambient ^a	$t \leq 10$ sec	R_{thJA}	26	33	$^\circ\text{C/W}$
	Steady State		65	81	
Maximum Junction-to-Case (Drain)			Steady State	R_{thJC}	

Notes

a. Surface Mounted on 1" x 1" FR4 Board.

MOSFET SPECIFICATIONS ($T_J = 25^\circ\text{C}$ UNLESS OTHERWISE NOTED)

Parameter	Symbol	Test Condition	Min	Typ	Max	Unit
Static						
Gate Threshold Voltage	$V_{GS(th)}$	$V_{DS} = V_{GS}, I_D = 250 \mu\text{A}$	0.6			V
Gate-Body Leakage	I_{GSS}	$V_{DS} = 0 \text{ V}, V_{GS} = \pm 12 \text{ V}$			± 100	nA
Zero Gate Voltage Drain Current	I_{DSS}	$V_{DS} = 24 \text{ V}, V_{GS} = 0 \text{ V}$			1	μA
		$V_{DS} = 24 \text{ V}, V_{GS} = 0 \text{ V}, T_J = 55^\circ\text{C}$			5	
On-State Drain Current ^a	$I_{D(on)}$	$V_{DS} \geq 5 \text{ V}, V_{GS} = 10 \text{ V}$	40			A
Drain-Source On-State Resistance ^a	$r_{DS(on)}$	$V_{GS} = 10 \text{ V}, I_D = 13.3 \text{ A}$		0.010	0.013	Ω
		$V_{GS} = 4.5 \text{ V}, I_D = 12.4 \text{ A}$		0.0125	0.015	
		$V_{GS} = 2.5 \text{ V}, I_D = 5 \text{ A}$		0.019	0.022	
Forward Transconductance ^a	g_{fs}	$V_{DS} = 15 \text{ V}, I_D = 13.3 \text{ A}$		50		S
Diode Forward Voltage ^a	V_{SD}	$I_S = 3.2 \text{ A}, V_{GS} = 0 \text{ V}$		0.75	1.2	V
Dynamic^b						
Total Gate Charge	Q_g	$V_{DS} = 15 \text{ V}, V_{GS} = 4.5 \text{ V}, I_D = 13.3 \text{ A}$		20	30	nC
Gate-Source Charge	Q_{gs}			5.8		
Gate-Drain Charge	Q_{gd}			7.1		
Turn-On Delay Time	$t_{d(on)}$	$V_{DD} = 15 \text{ V}, R_L = 15 \Omega$ $I_D \cong 1 \text{ A}, V_{GEN} = 4.5 \text{ V}, R_G = 6 \Omega$		27	40	ns
Rise Time	t_r			39	60	
Turn-Off Delay Time	$t_{d(off)}$			64	100	
Fall Time	t_f			33	50	
Source-Drain Reverse Recovery Time	t_{rr}		$I_F = 3.2 \text{ A}, di/dt = 100 \text{ A}/\mu\text{s}$		45	

Notes

- a. Pulse test; pulse width $\leq 300 \mu\text{s}$, duty cycle $\leq 2\%$.
b. Guaranteed by design, not subject to production testing.

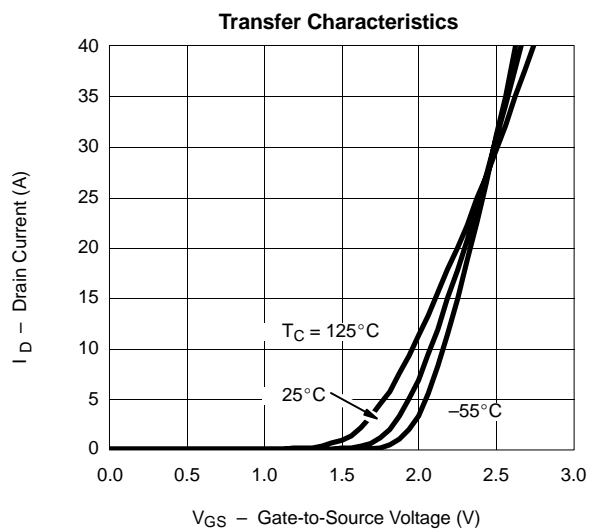
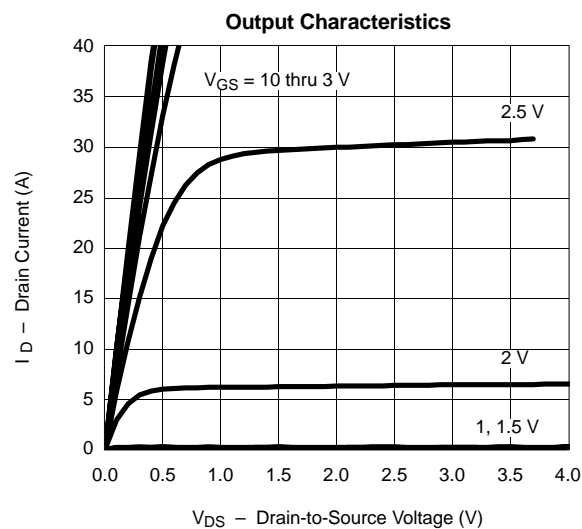
TYPICAL CHARACTERISTICS (25°C UNLESS NOTED)



TYPICAL CHARACTERISTICS (25 °C UNLESS NOTED)

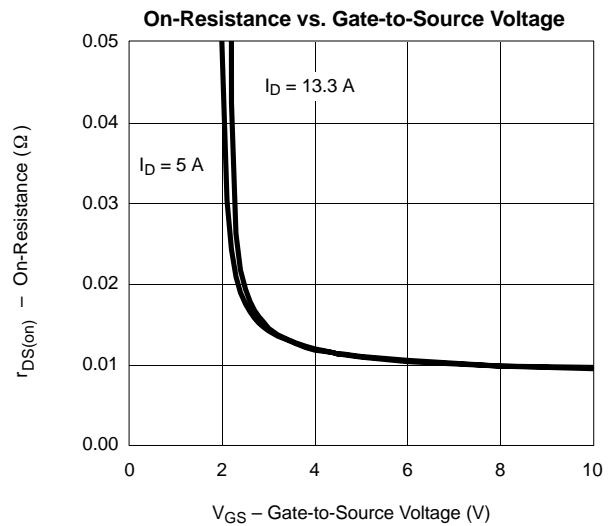
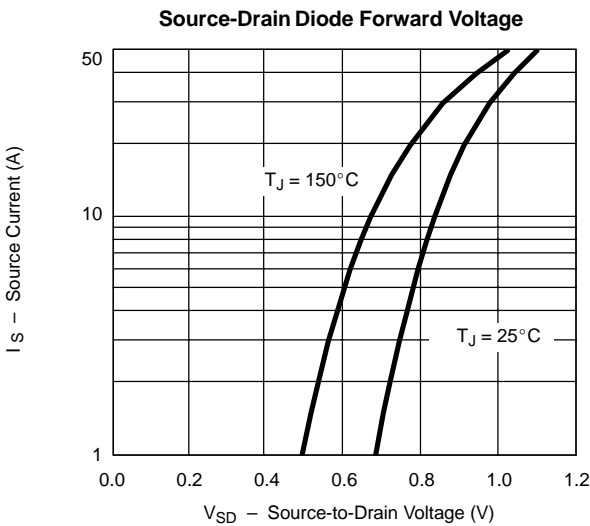
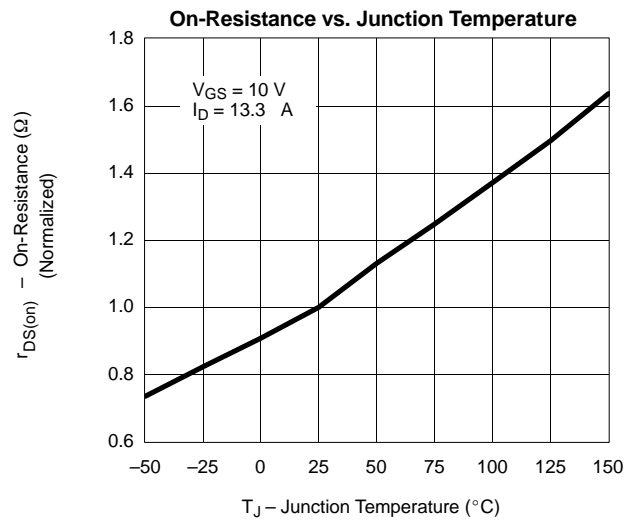
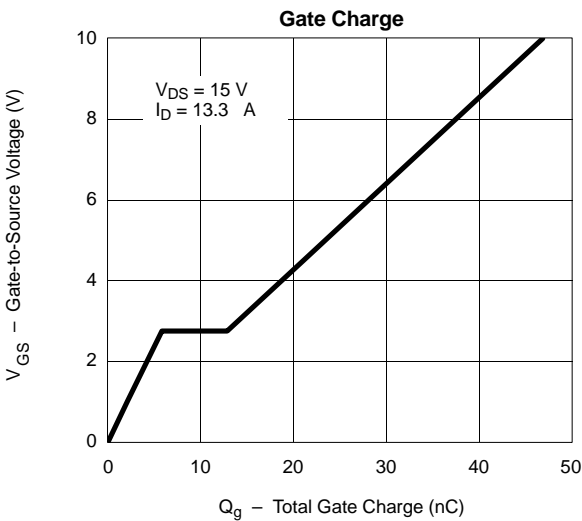
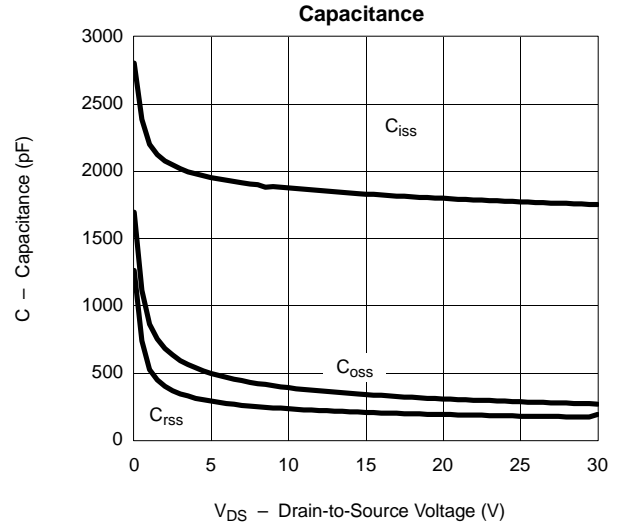
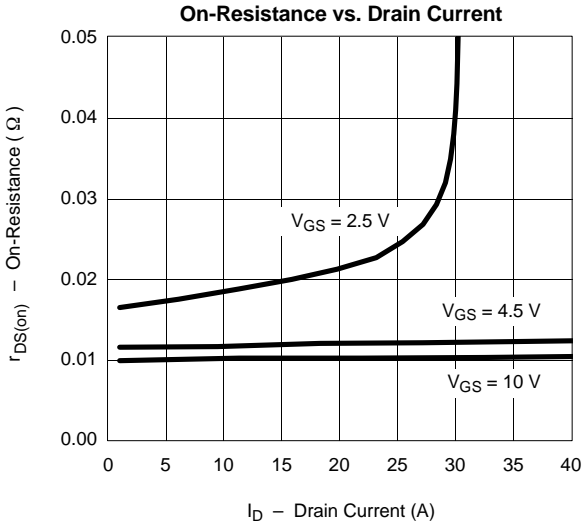

TYPICAL CHARACTERISTICS (25 °C UNLESS NOTED)

